

### Features:

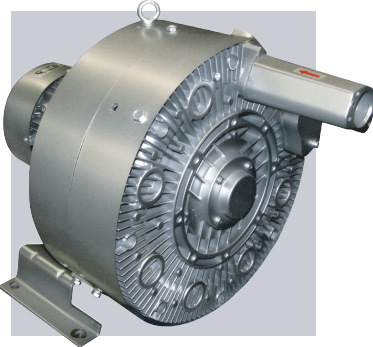

- Cooler running, outboard bearing provides maintenance-free operation
- Environmentally friendly oil-free technology
- Extremely quiet operation
- All motors are standard TEFC with Class F insulation, UL recognized, CE Compliant  
*Explosion-Proof motors available*
- Custom construction blowers are available
- Rugged die cast aluminum construction

Performance curve for Vacuum pump

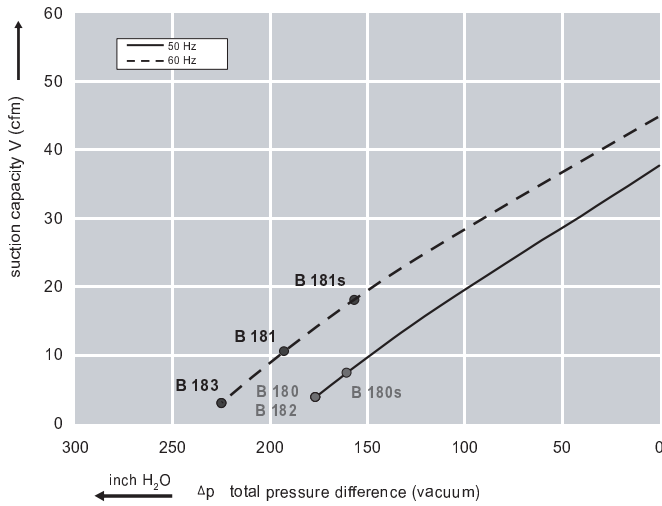

Performance curve for Compressor

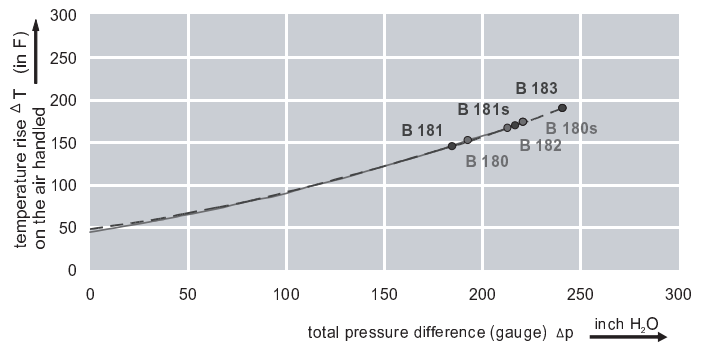
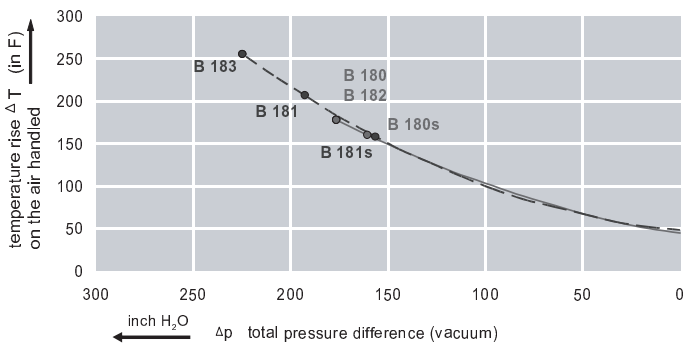
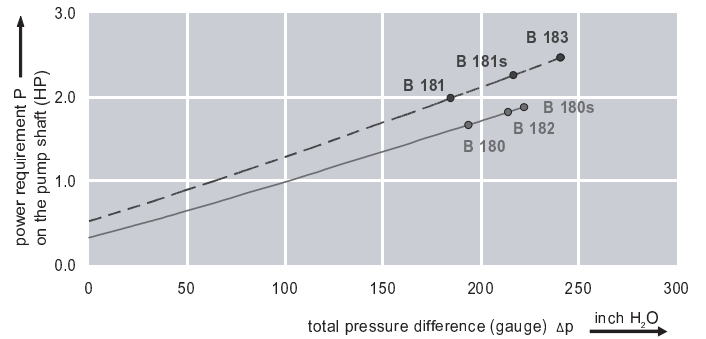
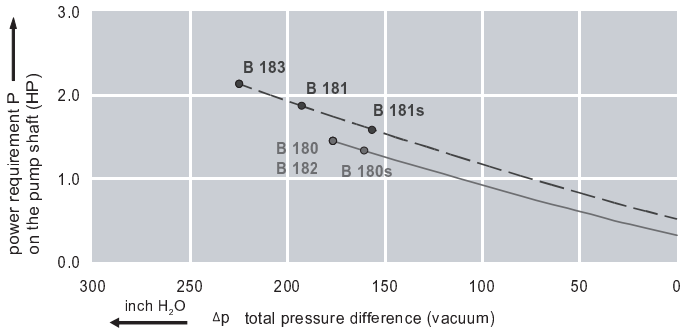
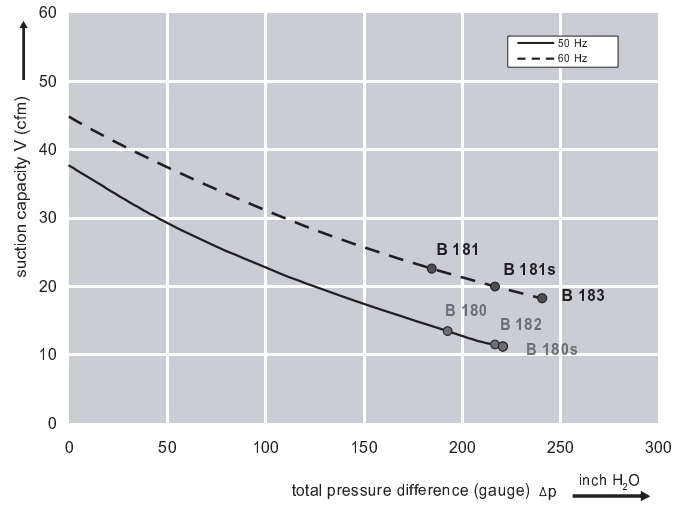

### Dimensions: (inches)

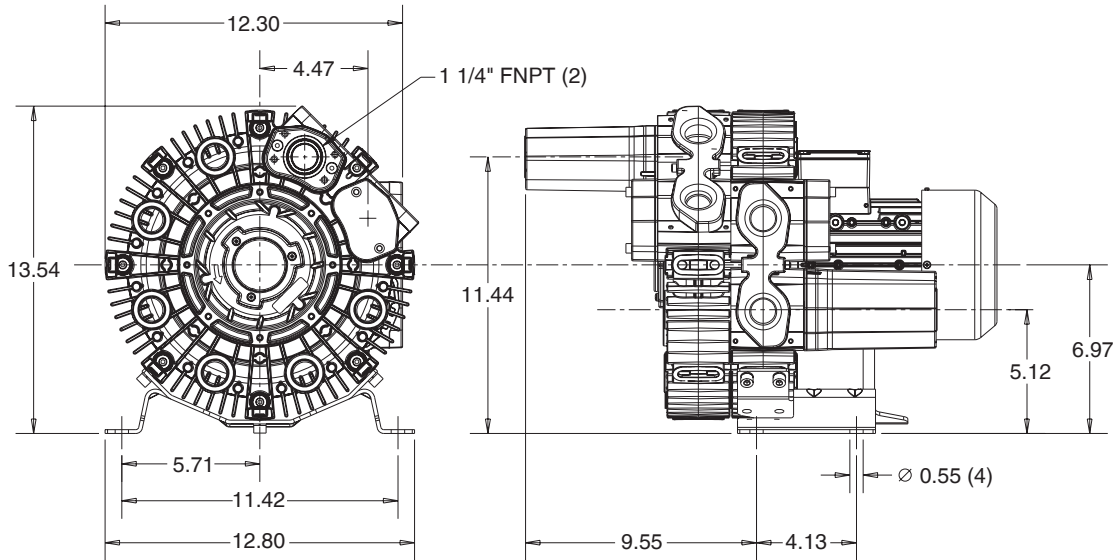

### Recommended Accessories:

#### Relief valve:

VC51Z (Vacuum)  
PC51Z (Pressure)

#### Filter:

ATF-125-1337  
(Vacuum)  
AFS-20-125-10  
(Pressure)

Specifications subject to change without notice. Please contact factory for specification updates.

### Selection & Ordering Data - Type 3BA7320

Curve No.	Order No.	Fre- quency Hz	Rated power HP	Input voltage		Input current		Permissible total differential pressure		Sound pressure level dB(A)	Weight lbs
				V		A		Vacuum inch H2O	Compressor inch H2O		
<b>3~ 50/60 Hz IP55 insulation material class F</b>											
B 180	3BA7320-0AT46	50	1.47	200D ... 240D	345Y ... 415Y	5.4D	3.1 Y	-177	193	59	64
B 181	3BA7320-0AT46	60	2.01	220D ... 250D	415Y ... 460Y	5.5D	3.2 Y	-193	185	63	64
B 182	3BA7320-0AT56	50	2.01	200D ... 240D	345Y ... 415Y	7.5D	4.3 Y	-177	217	59	66
B 183	3BA7320-0AT56	60	2.75	220D ... 250D	415Y ... 460Y	7.5D	4.4 Y	-225	241	63	66
<b>1~ 50/60 Hz IP55 with attached capacitor for continuous operation</b>											
B 180s	3BA7320-0AS75	50	2.0	115	230	19.4	9.7	-161	221	59	70
B 181s	3BA7320-0AS75	60	2.35	115	230	20.6	10.3	-157	217	63	70

Suitable for 208 Volt Operation

All curves are rated at 14.7 psia and 68°F ambient conditions and are reported in SCFM referenced to 68°F and 14.696 psia sea level conditions. Curve values are nominal, actual performance may vary by up to 10% of the values indicated. For inlet temperatures above approximately 80 °F or for handling gases other than air, please contact your Airtech sales representative for assistance.